

FORM 18638
JULY, 1933
PRINTED IN U. S. A.

LIST OF PARTS



MACHINE No. 81-63

THE SINGER MANUFACTURING COMPANY

From the library of: Diamond Needle Corp

COPYRIGHT, U. S. A.,
1922, 1932 AND 1933,
BY THE SINGER MANUFACTURING CO.
ALL RIGHTS RESERVED FOR ALL COUNTRIES

INSTRUCTIONS FOR OILING

BEFORE STARTING THE MACHINE apply Singer Cloth and Leather Oil to the oil cup in the bed of the machine until the reservoir is full. Also fill the oil cup at the top of the machine and thoroughly saturate the wick in the casting near the top of the needle bar. Then oil the needle bar link connection at the front of the machine, also the knife lever and presser lever bearings at the back of the machine.

THEREAFTER, replenish the oil supply in the reservoir about once each day, or often enough to keep it filled. Twice a day apply oil to the remainder of the oiling points.

INDEX

	PAGE
ACCESSORIES.....	10
BENCH STAND.....	15
FOOT LIFTER PARTS.....	17
KNEE LIFTER PARTS.....	18
MACHINE NO. 81-63.....	7
“ BASE.....	16
NUMERICAL LIST OF PARTS.....	21
PARTS REQUIRED FOR THREE-THREAD STITCH.....	15
THREAD UNWINDER.....	19

From the library of: Diamond Needle Corp

INSTRUCTIONS FOR ORDERING

In ordering from this list, use **ONLY** the part **NUMBER** in the **FIRST** column.

The number stamped on a Sewing Machine Part is in every case the number of the single part only.

Every combination of parts sent out as such has its specific number, which, although not stamped on the parts, must be used when ordering the combination.

Each number always indicates the **SAME PART** in whatever list it appears, or for whatever machine.

The letters after some of the numbers indicate the style of finish only, as follows:

- A—Hardened, Polished, Nickel Plated and Buffed
- B—Polished, Nickel Plated and Buffed
- C—Hardened Only
- D—Polished Only
- E—Soft, Not Polished
- F—Hardened and Polished
- H—Blued
- J—Nickel Plated Only
- K—Hardened and Nickel Plated
- L—Brass Plated
- M—Oxidized
- N—Japanned, Dull
- P—Japanned, Bright
- R—Merlized
- T—Copper Plated
- T. A.—Hardened, Polished, Copper and Nickel Plated and Buffed
- T. B.—Copper and Nickel Plated and Polished
- T. J.—Copper and Nickel Plated Only
- T. K.—Hardened, Copper and Nickel Plated
- T. M.—Copper Plated and Oxidized
- T. L.—Copper and Brass Plated
- U—Zinc Plated
- V—Silver Plated
- W—Polished and Nickel Plated
- Y—Black Nickel Plated Only
- Z—Chromium Plated
- Z. B.—Polished, Nickel Plated, Buffed and Chromium Plated
- Z. J.—Nickel and Chromium Plated

These letters **MUST BE USED** when they appear in the list; and **AFTER** the number **as** in the list.

In this series:

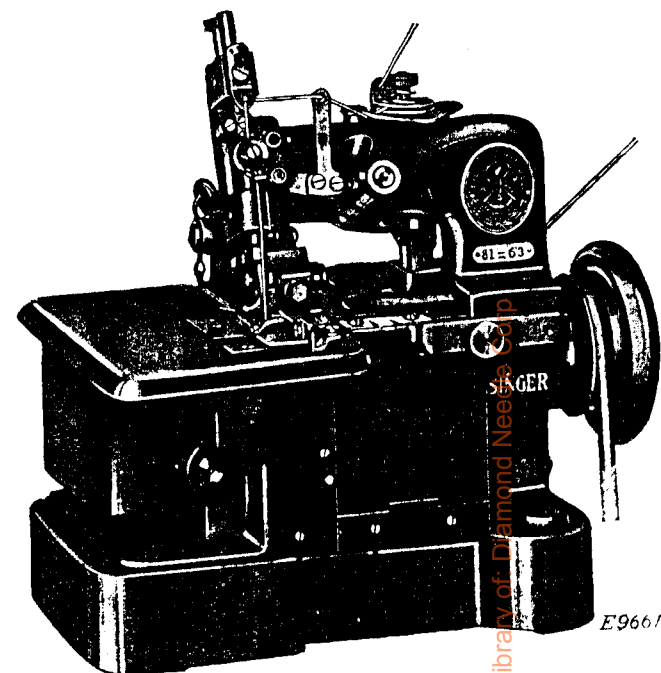
- 1 to 1500 and 50001 to 51500 are Screw Numbers
- 1501 to 1800 and 51501 to 51800 are Nut Numbers
- 1801 to 2000 and 51801 to 52000 are Roller Numbers
- 2001 to 50000 and 52001 and upward are numbers of Machine Parts

The figures in the second column refer only to the plates, illustrating the parts, and are **NOT TO BE USED** in ordering.

Parts marked with an asterisk (*) are furnished only when repairs are made at factory.

LIST OF PARTS COMPLETE

FOR



MACHINE No. 8163

FOR SERGING PANTS AND CUT EDGES OF CLOTH. NO TRIMMER. HAS A GUIDE ADJUSTABLE FOR DIFFERENT THICKNESSES AND WIDTH OF BIGHT. TWO-THREAD STITCH. FOOT LIFTER. HAS AN IMPROVED OILING SYSTEM, WHICH AUTOMATICALLY OILS ALL OF THE PRINCIPAL BEARINGS OF THE MACHINE. BALANCE WHEEL NO. 132632. DIAMETER OF BELT GROOVE 1 7/8 INCHES. SPEED 5000.

NO.	PLATE	NAME
*132522	—	Arm with 42253, 132580 and two each 462c, 624c and 132589.....
4389	7416	Arm Dowel Pin.....
68350	7416	" Oil Cup.....
949E	7417	" Screw.....
132632	20784	Balance Wheel, 1 7/8 in. pulley, with with 446c and 1258c.....

NO.	PLATE	NAME
1285c	7418	Balance Wheel Position Screw.....
446c	—	“ “ Set Screw.....
132524	20779	Cloth Plate with 132525.....
132601	20779	“ “ Extension (lower).....
233E	7416	“ “ “ “ Screw...
42108	7416	“ “ “ (upper).....
233E	7416	“ “ “ “ Screw...
*132525	—	“ “ Hinge Bracket.....
132526	7416	“ “ “ Stud.....
50150c	7416	“ “ “ “ Set Screw.....
42005	7416	“ “ Lock Spring.....
236c	7416	“ “ “ “ Screw.....
132527	—	Cloth Plate complete, Nos. 42005, 42108, 132524, 132601, two 236c and five 233E.....
42205	20780	Feed Bar with 1253c.....
132528	20786	“ “ Hinge Pin.....
1253c	20781	“ “ “ “ Set Screw.....
132529	20781	“ Connecting Rod with 171c, 1695J, 132530 and two 1057E.....
132643	—	Feed Connecting Rod 132529 with 132644.....
*132530	—	Feed Connecting Rod Cap.....
1057E	20781	“ “ “ “ Screw..
51292c	20781	“ “ “ “ Hinge Screw
171c	20781	“ “ “ “ “
		Clamping Screw.....
1695J	20781	Feed Connecting Rod Hinge Screw
		Clamping Screw Nut.....
1520J	20781	Feed Connecting Rod Hinge Screw
		Nut.....
42267	20782	Feed Dog, 24 teeth (16 teeth to the inch).....
190J	20781	Feed Dog Screw.....
*132531	—	“ Eccentric.....
*132532	—	“ “ Body.....
1036c	20781	“ “ “ “ Set Screw.....
19047	20781	“ “ Clamping Washer.....
201J	20781	“ “ “ “ Screw
132533	20781	“ “ Oil Tube.....
132644	20781	Feed Eccentric complete, Nos. 201J, 19047, 51145c, 132531 to 132533 and two 1036c.....
132651	20781	Feed Eccentric Cover.....
42102	20786	“ “ “ “ Holder.....
132634	—	“ “ “ “ 42102 with 132651 and two 50253J.....

NO.	PLATE	NAME
283w	20786	Feed Eccentric Cover Holder Thumb Screw.....
2749	20786	Feed Eccentric Cover Holder Thumb Screw Washer.....
50253J	20781	Feed Eccentric Cover Screw.....
132536	20783	“ “ Lubricator with 132537
132537	20783	“ “ “ “ Oil Wick (braided cotton).....
132635	20783	Feed Lifting Eccentric with two 462c..
132539	20783	“ “ “ “ Connection.....
462c	20783	“ “ “ “ Set Screw.....
51145c	20781	“ Regulating Screw.....
132625	20780	“ Rock Shaft.....
132626	—	Feed Rock Shaft complete, Nos. 42021 and 132625.....
42021	20783	Feed Rock Shaft Crank with 157E.....
157E	20783	“ “ “ “ Clamping Screw.....
132542	20783	Feed Rock Shaft Hinge Pin with 132544
132543	20783	“ “ “ “ “ Bushing...
132544	20783	“ “ “ “ “ “ Oil Wick (braided cotton).....
1036c	20783	Feed Rock Shaft Hinge Pin Bushing Set Screw.....
132544	20783	Feed Rock Shaft Hinge Pin Oil Wick (braided cotton).....
*132545	—	Frame.....
132546	20779	“ Bottom Cover with 132594.....
132547	20779	“ “ “ “ Gasket.....
190E	20781	“ “ “ “ Screw.....
132548	7416	“ Oil Cup.....
132549	20784	“ Rotary Shaft with 132558 and 132559.....
132616	—	Frame Rotary Shaft 132549 with 132585 and 132695.....
132550	7416	Frame Rotary Shaft Bushing (front) with 132552.....
132552	20785	Frame Rotary Shaft Bushing (front) Oil Pad (braided cotton).....
132551	7416	Frame Rotary Shaft Bushing (front) Oil Wick (braided cotton).....
51332c	—	Frame Rotary Shaft Bushing (front) Set Screw.....
132553	20783	Frame Rotary Shaft Crank with 1036c and 1375c.....
1375c	20783	Frame Rotary Shaft Crank Position Screw.....

NO.	PLATE	NAME
1036c	20783	Frame Rotary Shaft Crank Set Screw...
132551	20784	" " " Flanged Bushing (back).....
132694	-----	Frame Rotary Shaft Flanged Bushing (back) 132554 with 132555, 132556, 132603 and 132692.....
132555	20780	Frame Rotary Shaft Flanged Bushing (back) Oil Pad, large (braided cotton)
132556	7416	Frame Rotary Shaft Flanged Bushing (back) Oil Pad, small (braided cotton)
132603	20780	Frame Rotary Shaft Flanged Bushing (back) Oil Pad Retainer.....
132551	7416	Frame Rotary Shaft Flanged Bushing (back) Oil Wick (braided cotton)....
51332c	-----	Frame Rotary Shaft Flanged Bushing (back) Set Screw.....
132558	20780	Frame Rotary Shaft Oil Pad (braided cotton).....
132559	20780	Frame Rotary Shaft Oil Pad Retainer..
*132692	-----	" " " " Sling Cover...
132638	20784	" Side Cover (left) with 19045....
19045	7416	" " " " Handle.....
330w	7416	" " " " Screw.....
42028	20784	" " " (right, hinged)....
42192	20786	" " " " Lock Spring
330w	7416	" " " " " " " " Screw.....
330w	7416	Frame Side Cover (right) Screw.....
132636	20779	" Top Cover.....
583F	7417	" " " " Screw (large).....
742F	7417	" " " " (small).....
38571	20786	Guide with 230H and 38572.....
217F	7412	" Screw.....
7071	20786	" " Washer.....
38572	20786	" Smoothing Plate.....
230H	20786	" " " " Screw.....
42114	20785	Looper (left hand).....
132566	20785	" " " Lever with 50117c and two 1253c.....
132567	20785	Looper (left hand) Lever Connecting Stud with 68497.....
68497	-----	Looper (left hand) Lever Connecting Stud Oil Pad.....
132645	20785	Looper (left hand) Lever Connecting Stud Hinge Pin.....
1253c	20785	Looper (left hand) Lever Connecting Stud Hinge Pin Set Screw.....

NO.	PLATE	NAME
132569	20785	Looper (left hand) Lever Hinge Stud with 132552.....
132552	20785	Looper (left hand) Lever Hinge Stud Oil Pad (braided cotton).....
132571	20785	Looper (left hand) Lever Hinge Stud Oil Wick (braided cotton).....
1036c	20781	Looper (left hand) Lever Hinge Stud Set Screw.....
50117c	20785	Looper (left hand) Set Screw.....
132630	20785	" (right hand).....
132698	-----	" " " and Spreader Lever with 233E, 241E and 50200c.....
132703	-----	Looper (right hand) and Spreader Lever 132698 with 132699.....
132573	7412	Looper (right hand) and Spreader Lever Ball Stud.....
132695	-----	Looper (right hand) and Spreader Lever Ball Stud 132573 with 132696.....
132696	-----	Looper (right hand) and Spreader Lever Ball Stud Oil Pad (felt).....
50200c	7413	Looper (right hand) and Spreader Lever Ball Stud Set Screw.....
132574	7412	Looper (right hand) and Spreader Lever Connection with 132575, 132576 and four 1057E.....
132617	-----	Looper (right hand) and Spreader Lever Connection 132574 with 132553 and 132695.....
*132575	-----	Looper (right hand) and Spreader Lever Connection Cap (lower).....
1057E	7412	Looper (right hand) and Spreader Lever Connection Cap (lower) Screw.....
*132576	-----	Looper (right hand) and Spreader Lever Connection Cap (upper).....
1057E	7412	Looper (right hand) and Spreader Lever Connection Cap (upper) Screw.....
132577	7412	Looper (right hand) and Spreader Lever Connection Guide.....
196F	7412	Looper (right hand) and Spreader Lever Connection Guide Screw.....
132699	-----	Looper (right hand) and Spreader Lever Hinge Pin with 132700.....
132543	20783	Looper (right hand) and Spreader Lever Hinge Pin Bushing.....
132700	-----	Looper (right hand) and Spreader Lever Hinge Pin Bushing Oil Pad (braided cotton).....

Copyright © 2010 by Farmall, Inc.

NO.	PLATE	NAME
1036c	20781	Looper (right hand) and Spreader Lever Hinge Pin Bushing Set Screw.....
132700	——	Looper (right hand) and Spreader Lever Hinge Pin Oil Pad (braided cotton) for 132699.....
1036c	20781	Looper (right hand) and Spreader Lever Hinge Pin Set Screw.....
241E	——	Looper (right hand) and Spreader Lever Oil Plug Screw.....
197J	20785	Looper (right hand) Screw.....
42054	7412	Needle Bar.....
42253	7412	“ “ Bushing (lower).....
132580	7412	“ “ “ (upper).....
132581	7412	“ “ “ “ Oil Pad (braided cotton).....
132621	7412	Needle Bar Bushing (upper) Oil Pad Cover.....
217J	7412	Needle Bar Bushing (upper) Oil Pad Cover Screw.....
462c	20783	Needle Bar Bushing Set Screw.....
132598	7412	“ “ Connecting Bracket with 187E and 223E.....
187E	7412	Needle Bar Connecting Bracket Clamping Screw.....
132582	7412	Needle Bar Connecting Link.....
132583	7412	“ “ “ “ Hinge Pin with 132581.....
132584	7412	Needle Bar Connecting Link Hinge Pin Oil Pad (wick).....
223E	7412	Needle Bar Connecting Link Hinge Pin Set Screw for 132598.....
620c	7413	Needle Bar Connecting Link Hinge Pin Set Screw for 132597.....
132585	7413	Needle Bar Connecting Rod with 132586 132587 and four 1057E.....
*132586	——	Needle Bar Connecting Rod Cap (lower)
1057E	7413	“ “ “ “ “ “ “ “ Screw.....
*132587	——	Needle Bar Connecting Rod Cap (upper)
1057E	7413	“ “ “ “ “ “ “ “ Screw.....
132577	7412	Needle Bar Connecting Rod Guide.....
196E	7412	“ “ “ “ “ “ “ “ Screw.....
132588	7413	“ “ Crank (back) with 132590 and two 1259c.....
132573	7412	Needle Bar Crank (back) Ball Stud

NO.	PLATE	NAME
132695	——	Needle Bar Crank (back) Ball Stud 132573 with 132696.....
132696	——	Needle Bar Crank (back) Ball Stud Oil Pad (felt).....
1259c	7413	Needle Bar Crank (back) Ball Stud Set Screw.....
132589	7413	Needle Bar Crank (back) Bushing....
624c	7413	“ “ “ “ “ “ Set Screw.....
132590	7413	Needle Bar Crank (back) Oil Pad (wick).....
1259c	7413	Needle Bar Crank (back) Set Screw....
132597	7413	“ “ “ (front) with 620c, 1259c and 50200c.....
132615	——	Needle Bar Crank (front) 132597 with 132582, 132598 and two 132583.....
1259c	7413	Needle Bar Crank (front) Position Screw.....
50200c	7413	Needle Bar Crank (front) Set Screw....
42115	7413	“ “ Thread Retainer Bracket
228J	20786	“ “ “ “ “ “ “ “ Screw.....
42483	7413	Needle Bar Thread Retainer Disc.....
93c	7413	“ “ “ “ “ “ Screw....
10107	7413	“ “ “ “ “ “ Spring....
1728c	7412	“ Clamping Nut.....
42066	7413	“ Guard.....
42195	20786	“ “ Holder.....
1101c	7418	“ “ “ “ Screw.....
171E	7413	“ “ “ “ Screw.....
42268	20782	Presser Foot Chaining-off Finger.....
233J	20782	“ “ “ “ “ “ Screw
132609	——	“ “ “ “ “ “ Plate.....
132610	20782	“ “ “ “ “ “ Collar with 240c.....
132611	20782	Presser Foot Chaining-off Plate Collar Guide Pin.....
735c	20782	Presser Foot Chaining-off Plate Collar Guide Pin Set Screw.....
240c	20782	Presser Foot Chaining-off Plate Collar Set Screw.....
62527	20782	Presser Foot Hinge Pin.....
42270	——	“ “ Plate.....
132612	——	“ “ Shank with 735c.....
14058	20782	“ “ Spring.....

From the Internet Archive: https://www.archive.org/details/needle-bar-crank-81-63

NO.	PLATE	NAME
132637	20782	Presser Foot (spring hinged) complete, Nos. 233j, 14058, 42268, 42270, 62527 and 132609 to 132612.....
1324c	20782	Presser Foot Screw.....
39541	20782	" " " Washer.....
42069	20784	" Lever.....
42376	-----	" " 42069 with 42015.....
42045	20786	" " Hinge Stud.....
1120c	7417	Presser Lever Hinge Stud Set Screw....
42070	7414	" " Lifter.....
85d	7414	" " " Hinge Screw.....
1377c	7418	" " Screw Stud (eccentric)....
1517j	20786	" " " " Nut.....
42071	7414	" " Spring.....
1378b	7414	Pressure Regulating Thumb Screw.....
132631	20785	Spreader.....
197j	20785	" Screw.....
2102	7414	Tension (looper, left hand) Disc.....
1560c	7414	" " " " Regulating Thumb Nut.....
50148c	7414	Tension (looper, left hand) Screw Stud
124687	-----	" " " " " "
		50148c with 1560c.....
54883	7414	Tension (looper, left hand) Spring....
132599	7414	" " " " Thread Guide.....
2102	7414	Tension (needle thread) Disc.....
1560c	7414	" " " " Regulating Thumb Nut.....
916c	7414	Tension (needle thread) Screw Stud....
41209	-----	" " " " " " 916c with 1560c.....
10148	7414	Tension (needle thread) Spring.....
42082	7414	" " " " Thread Guide.....
42242	20786	Thread (looper, left hand) Eyelet.....
233e	7416	" " " " " " Screw
42084	7417	" " " " " " Tube.....
462c	20783	" " " " " " Set Screw.....
42096	20786	Thread (needle) Eyelet.....
217j	7412	" " " " Screw.....
42428	20786	" " " " Take-up.....
197j	7414	" " " " Screw.....
42272	20782	Throat Plate for 42267.....
742e	7417	" " " " Screw.....

PARTS REQUIRED FOR THREE-THREAD STITCH

NO.	PLATE	NAME
132630	20785	Looper (right hand).....
2102	7414	Tension (looper, right hand) Disc.....
1560c	7414	" " " " " " Regulating Thumb Nut.....
828c	7414	Tension (looper, right hand) Screw Stud
42418	-----	" " " " " " " " 828c with 1560c.....
10148	7414	Tension (looper, right hand) Spring....
57076	7414	" " " " " " Thread Guide.....
132629	7417	Thread (looper, left hand) Eyelet.....
42122	7417	" " " " " " Nipper Spring (lower).....
42123	7417	Thread (looper, left hand) Nipper Spring (upper).....
176j	7417	Thread (looper, left hand) Nipper Spring Screw.....
42126	7417	Thread (looper, left hand) Pull-off....
132591	7417	" (looper, right hand) Pull-off
42244	7417	" " " " " " Eyelet.....
207j	7417	Thread (looper, right hand) Pull-off Eyelet Screw.....
42093	7417	Thread (looper, right hand) Staple....
190j	20781	" " " " " " Screw
42127	7417	" " " " " " Take-up....
197j	7414	" " " " " " Screw
132622	7417	" (needle) Eyelet.....
233j	7416	" " " " " " Screw.....
132623	7417	" " " " " " Take-up.....

BENCH STAND

NO.	PLATE	NAME
79768	-----	Bench Stand with 27098, two each 28291, 46548, wood screws 1½ in. No. 12 and eight wood screws 5/8 in. No. 5.....
28291	7418	Cover Hinge.....
27998	7418	" Hook and Eye (brass) with wood screw ½ in. No. 5.....
46548	7418	Cover Rest (felt).....

ACCESSORIES

NO.	PLATE	NAME
1407E	5563	Machine Base Thumb Screw, for 3 in. table.....
1408E	5563	Machine Base Thumb Screw, for 2 in. table.....
14063	7418	Machine Base Thumb Screw Spring
9842	7419	“ “ “ “ “ “ Washer.....
132602	7418	Machine Base Thumb Screw Washer...
120344	5566	Oiler (copper plated) with 120345.....
120345	5566	“ Spout, 5 in. long.....
120440	5566	Screw Driver.....
42090	5566	Threading Wire.....
120341	5566	Tweezers (curved).....
68547	7418	Wrench for 1324 and 1728.....
8908	5566	“ “ 1520.....
4822	5566	“ “ 1547.....

MACHINE BASE

NO.	PLATE	NAME
132647	20779	Machine Base.....
132595	7419	“ “ Cushion (large) felt.....
42088	7419	“ “ “ (small) felt.....
132618	7419	“ “ “ “ “ for 1407 or 1408.....
935E	7419	Machine Base Cushion (small) Screw...
132596	7419	“ “ “ (leather).....
132593	7419	“ “ Oil Drain Strainer.....
131019	20784	“ “ “ Pipe.....
131020	20784	“ “ “ Valve.....
54477	7419	“ “ Screw Stud.....
51576E	7419	“ “ “ “ Nut.....
9842	7419	“ “ “ “ Washer.....
132594	7419	“ “ Thumb Screw Bushing..
132592	-----	Machine Base complete, Nos. 131019, 131020, 132593, 132596, 132618, 132647, three each 9842, 51576E, 54477 and four each 935E, 42088 and 132595.....

FOOT LIFTER PARTS

NO.	PLATE	NAME
6439	-----	Chain, 36 in. to 45 in., with 56864 and 56865.....

NOTE: When ordering No. 6439 state length required.

4879	5566	Chain Connecting Link.....
56864	5566	“ Hook (large).....
56865	7418	“ “ (small).....
42130	20780	Lifting Lever.....
42131	20780	“ “ Bracket.....
1229c	20780	“ “ “ Screw.....
1301D	20780	“ “ Hinge Screw.....
42132	20780	“ “ Spring.....
1148F	20780	“ “ Stop Screw.....
1547J	20786	“ “ “ Nut.....
4881	20779	Treadle.....
4882	5566	“ Shaft.....
4883	5566	“ Spring.....
4884	20779	“ Stand.....
4885	20779	Treadle complete, Nos. 4879, 4881 to 4884 and two wood screws 1 in. No. 16
42133	-----	Foot Lifter complete, Nos. 1301D, 4885, 6439, 42130 to 42132 and two each 1148F, 1229c and 1547J.....

Genuine Singer Needles should be used in Singer Machines. These Needles and their Containers are marked with the Company's Trade Mark "SIMANCO." 1

Needles in Containers marked "For Singer Machines" are not Singer made needles. 2

From the files of Diamond Needle Corp.

KNEE LIFTER PARTS

NO.	PLATE	NAME
42130	20780	Lifting Lever.....
42131	20780	“ “ Bracket.....
1229c	20780	“ “ “ Screw.....
42142	20779	“ “ Connecting Rod.....
1301D	20780	“ “ Hinge Screw.....
42132	20780	“ “ Spring.....
1148F	20780	“ “ Stop Screw.....
1547J	20786	“ “ “ Nut.....
2763	20779	Rock Shaft.....
12242	20779	“ “ Hanger with two wood screws 1 in. No. 10.....
2765	20779	Rock Shaft Knee Arm.....
2766	20779	“ “ “ “ Hub with 356c..
356c	7418	“ “ “ “ Set Screw..
2768	—	Rock Shaft Knee Arm complete, Nos. 2765 to 2767.....
2767	20779	Rock Shaft Knee Plate with 356c.....
356c	7418	“ “ “ “ Set Screw.....
6337	20779	“ “ Lifting Bracket with two 356c.....
7125	20779	Rock Shaft Lifting Bracket Hook....
356c	7418	“ “ “ “ “ Set Screw.....
356c	7418	Rock Shaft Lifting Bracket Set Screw..
2770	20779	“ “ Stop Dog with 356c.....
356c	7418	“ “ “ “ Set Screw.....
42143	20779	Rock Shaft complete, Nos. 2763, 2768, 6337, 7125 and two each 2770 and 12242.....
42144	—	Knee Lifter complete, Nos. 1301D, 42130 to 42132, 42142, 42143 and two each 1148F, 1229c and 1547J.....

THREAD UNWINDER

FOR TWO SPOOLS

NO.	PLATE	NAME
225257	20787	Spool Rest (for two spools) with 201018c.....
150203	—	Spool Rest Cushion (felt).....
225388	20787	“ “ Rod.....
200383c	7418	“ “ “ Set Screw.....
201018c	7418	“ “ “ Set Screw.....
202490	20787	“ Stand with 200383c.....
225391	20787	Thread Guide.....
201696J	7418	“ “ Lock Nut.....
225326	7418	“ “ Position Cup.....
225324	20787	“ “ Rod with 208E and 225322
208E	20786	“ “ “ Screw.....
225322	7418	“ “ “ Washer.....
*150085	—	“ Separator.....
150086	20787	“ “ 150085 with 150059..
*150059	—	“ “ Bracket.....
150060	20787	“ “ “ Arm with 164J and 9525.....
164J	7418	Thread Separator Bracket Arm Clamping Screw.....
9525	7418	Thread Separator Bracket Arm Clamping Screw Washer.....
164J	7418	Thread Separator Bracket Screw.....
9525	7418	“ “ “ “ Washer
150087	—	Thread Separator complete, Nos. 164J, 9525, 150060 and 150086.....
150088	20787	Thread Unwinder complete, Nos. 150087, 201696J, 202490, 225257, 225324, 225326, 225388, two each 150203, 225391 and three wood screws 7/8 in. No. 12.....
27739	7234	Thread Cone (wood) for large cones....
225390	7234	“ “ Holder, for inverted cones

NOTE: Nos. 27739 and 225390 are used with, but not included in 150088.

NUMERICAL LIST OF PARTS
FOR
MACHINE No. 81-63

From the file of the

NUMERICAL LIST OF PARTS

NO.	PLATE	NAME
85D	7414	Presser Lever Lifter Hinge Screw.....
93C	7413	Needle Bar Thread Retainer Screw.....
157E	20783	Feed Rock Shaft Crank Clamping Screw for 42021.....
164J	7418	Thread Unwinder Thread Separator Bracket Arm Clamping Screw for 150060.....
164J	7418	Thread Unwinder Thread Separator Bracket Screw for 150087.....
171c	20781	Feed Connecting Rod Hinge Screw Clamping Screw for 132529.....
171F	7413	Needle Guard Screw.....
176j	7417	Thread (looper, left hand) Nipper Spring Screw.....
187E	7412	Needle Bar Connecting Bracket Clump- ing Screw for 132598.....
190E	20781	Frame Bottom Cover Screw.....
190j	20781	Feed Dog Screw.....
190j	20781	Thread (looper, right hand) Staple Screw
196F	7412	Looper (right hand) and Spreader Lever Connection Guide Screw.....
196F	7412	Needle Bar Connecting Rod Guide Screw.....
197J	20785	Looper (right hand) Screw.....
197J	20785	Spreader Screw.....
197J	7414	Thread (needle) Take-up Screw.....
197J	7414	" (looper, right hand) Take-up Screw.....
201J	20781	Feed Eccentric Clamping Washer Screw for 132644.....
207J	7417	Thread (looper, right hand) Pull-off Eyelet Screw.....
208E	20786	Thread Unwinder Thread Guide Rod Screw for 225324.....
217F	7412	Guide Screw.....
217J	7412	Needle Bar Bushing (upper) Oil Pad Cover Screw.....
217J	7412	Thread (needle) Eyelet Screw.....
223F	7412	Needle Bar Connecting Link Hinge Pin Set Screw for 132598.....
228J	20786	Needle Bar Thread Retainer Bracket Screw.....
230H	20786	Guide Smoothing Plate Screw for 38571

NO.	PLATE	NAME
233E	7416	Cloth Plate Extension (lower) Screw for 132527.....
233E	7416	Cloth Plate Extension (upper) Screw for 132527.....
233E	7416	Thread (looper, left hand) Eyelet Screw for 132698.....
233J	20782	Presser Foot Chaining-off Finger Screw for 132637.....
233J	7416	Thread (looper, left hand) Eyelet Screw
233J	7416	" (needle) Eyelet Screw.....
236c	7416	Cloth Plate Lock Spring Screw for 132527.....
240c	20782	Presser Foot Chaining-off Plate Collar Set Screw for 132610.....
241E	---	Looper (right hand) and Spreader Lever Oil Plug Screw for 132698.....
283w	20786	Feed Eccentric Cover Holder Thumb Screw.....
330w	7416	Frame Side Cover (left) Screw.....
330w	7416	" " (right) Lock Spring Screw.....
330w	7416	Frame Side Cover (right) Screw.....
356c	7418	Rock Shaft Knee Arm Hub Set Screw for 2766.....
356c	7418	Rock Shaft Knee Plate Set Screw for 2767.....
356c	7418	Rock Shaft Lifting Bracket Hook Set Screw for 6337.....
356c	7418	Rock Shaft Lifting Bracket Set Screw for 6337.....
356c	7418	Rock Shaft Stop Dog Set Screw for 2770.....
446c	---	Balance Wheel Set Screw for 132632....
462c	20783	Feed Lifting Eccentric Set Screw for 132635.....
462c	20783	Needle Bar Bushing Set Screw for 132522.....
462c	20783	Thread (looper, left hand) Tube Set Screw.....
583F	7417	Frame Top Cover Screw (large).....
620c	7413	Needle Bar Connecting Link Hinge Pin Set Screw for 132597.....
624c	7413	Needle Bar Crank (back) Bushing Set Screw for 132522.....
735c	20782	Presser Foot Chaining-off Plate Collar Guide Pin Set Screw for 132612.....
742F	7417	Frame Top Cover Screw (small).....

NO.	PLATE	NAME
742F	7417	Throat Plate Screw.....
828c	7414	Tension (looper, right hand) Screw Stud for 42418.....
916c	7414	Tension (needle thread) Screw Stud for 44209.....
935E	7419	Machine Base Cushion (small) Screw for 132592.....
949E	7417	Arm Screw.....
1036c	20781	Feed Eccentric Body Set Screw for 132644.....
1036c	20783	Feed Rock Shaft Hinge Pin Bushing Set Screw.....
1036c	20783	Frame Rotary Shaft Crank Set Screw for 132553.....
1036c	20781	Looper (left hand) Lever Hinge Stud Set Screw.....
1036c	20781	Looper (right hand) and Spreader Lever Hinge Pin Bushing Set Screw.....
1036c	20781	Looper (right hand) and Spreader Lever Hinge Pin Set Screw.....
1057E	20781	Feed Connecting Rod Cap Screw for 132529.....
1057E	7412	Looper (right hand) and Spreader Lever Connection Cap (lower) Screw for 132574.....
1057E	7412	Looper (right hand) and Spreader Lever Connection Cap (upper) Screw for 132574.....
1057E	7413	Needle Bar Connecting Rod Cap (lower) Screw for 132585.....
1057E	7413	Needle Bar Connecting Rod Cap (upper) Screw for 132585.....
1101c	7418	Needle Guard Holder Screw.....
1120c	7417	Presser Lever Hinge Stud Set Screw...
1148F	20780	Lifting Lever Stop Screw for 41133 and 42144.....
1229c	20780	Lifting Lever Bracket Screw for 42133 and 42144.....
1253c	20781	Feed Bar Hinge Pin Set Screw for 42205.....
1253c	20785	Looper (left hand) Lever Connecting Stud Hinge Pin Set Screw for 132566
1259c	7413	Needle Bar Crank (back) Ball Stud Set Screw.....
1259c	7413	Needle Bar Crank (back) Set Screw for 132588.....

NO.	PLATE	NAME
1259c	7413	Needle Bar Crank (front) Position Screw for 132597.....
1285c	7418	Balance Wheel Position Screw for 132632.....
1301b	20780	Lifting Lever Hinge Screw for 42133 and 42144.....
1324c	20782	Presser Foot Screw.....
1375c	20783	Frame Rotary Shaft Crank Position Screw for 132553.....
1377c	7418	Presser Lever Screw Stud (eccentric)....
1378b	7414	Pressure Regulating Thumb Screw.....
1407e	5563	Machine Base Thumb Screw, for 3 in. table (Accessories).....
1408e	5563	Machine Base Thumb Screw, for 2 in. table (Accessories).....
1520j	20781	Feed Connecting Rod Hinge Screw Nut
1547j	20786	Lifting Lever Stop Screw Nut for 42133 and 42144.....
1547j	20786	Presser Lever Screw Stud Nut.....
1560c	7414	Tension (looper, left hand) Regulating Thumb Nut for 124687.....
1560c	7414	Tension (looper, right hand) Regulating Thumb Nut for 42418.....
1560c	7414	Tension (needle thread) Regulating Thumb Nut for 44209.....
1695j	20781	Feed Connecting Rod Hinge Screw Clamping Screw Nut for 132529....
1728c	7412	Needle Clamping Nut.....
2102	7414	Tension (looper, left hand) Disc.....
2102	7414	" (looper, right hand) Disc.....
2102	7414	" (needle thread) Disc.....
2749	20786	Feed Eccentric Cover Holder Thumb Screw Washer.....
2763	20779	Rock Shaft for 42143.....
2765	20779	" " Knee Arm for 2768.....
2766	20779	" " " " Hub with 356c, for 2768.....
2767	20779	Rock Shaft Knee Plate with 356c, for 2768.....
2768	—	Rock Shaft Knee Arm complete for 42143, Nos. 2765 to 2767.....
2770	20779	Rock Shaft Stop Dog with 356c, for 42143.....
4389	7416	Arm Dowel Pin.....
4822	5566	Wrench for 1547 (Accessories).....
4879	5566	Chain Connecting Link for 4885.....

NO.	PLATE	NAME
Nos. 4881 TO 4884 FOR 4885		
4881	20779	Treadle.....
4882	5566	" Shaft.....
4883	5566	" Spring.....
4884	20779	" Stand.....
4885	20779	Treadle complete for 42133, Nos. 4879, 4881 to 4884 and two wood screws 1 in. No. 16.....
6337	20779	Rock Shaft Lifting Bracket with two 356c, for 42143.....
6439	—	Chain, 36 in. to 45 in., with 56864 and 56865, for 42133.....
7071	20786	Guide Screw Washer.....
7125	20779	Rock Shaft Lifting Bracket Hook for 42143.....
8908	5566	Wrench for 1520 (Accessories).....
9525	7418	Thread Unwinder Thread Separator Bracket Arm Clamping Screw Washer for 150060.....
9525	7418	Thread Unwinder Thread Separator Bracket Screw Washer for 150087....
9842	7419	Machine Base Thumb Screw Spring Washer (Accessories).....
9842	7419	Machine Base Screw Stud Nut Washer for 132592.....
10107	7413	Needle Bar Thread Retainer Spring ...
10148	7414	Tension (needle thread) Spring.....
10148	7414	" (looper, right hand) Spring....
12242	20779	Rock Shaft Hanger with two wood screws 1 in. No. 10, for 42143.....
14058	20782	Presser Foot Spring for 132637.....
14063	7418	Machine Base Thumb Screw Spring (Accessories).....
19045	7416	Frame Side Cover (left) Handle for 132638.....
19047	20781	Feed Eccentric Clamping Washer for 132644.....
27739	7234	Thread Unwinder Thread Cone (wood) for large cones, for 150088.....
27998	7418	Bench Stand Cover Hook and Eye (brass) with wood screw ½ in. No. 5, for 79768.....
28291	7418	Bench Stand Cover Hinge for 79768....
38571	20786	Guide with 230H and 38572.....
38572	20786	" Smoothing Plate for 38571.....
39541	20782	Presser Foot Screw Washer.....

NO.	PLATE	NAME
42005	7416	Cloth Plate Lock Spring for 132527....
42021	20783	Feed Rock Shaft Crank with 157E, for 132626.....
42028	20784	Frame Side Cover (right, hinged).....
42045	20786	Presser Lever Hinge Stud for 42376....
42054	7412	Needle Bar.....
42066	7413	“ Guard.....
42069	20784	Presser Lever for 42376.....
42070	7414	“ “ Lifter.....
42071	7414	“ “ Spring.....
42082	7414	Tension (needle thread) Thread Guide..
42084	7417	Thread (looper, left hand) Tube.....
42088	7419	Machine Base Cushion (small) felt, for 132592.....
42090	5566	Threading Wire (Accessories).....
42093	7417	Thread (looper, right hand) Staple.....
42096	20786	“ (needle) Eyelet.....
42102	20786	Feed Eccentric Cover Holder for 132634
42108	7416	Cloth Plate Extension (upper) for 132527.....
42114	20785	Looper (left hand).....
42115	7413	Needle Bar Thread Retainer Bracket...
42122	7417	Thread (looper, left hand) Nipper Spring (lower).....
42123	7417	Thread (looper, left hand) Nipper Spring (upper).....
42126	7417	Thread (looper, left hand) Pull-off.....
42127	7417	“ (looper, right hand) Take-up...
42128	20786	“ (needle) Take-up.....
42130	20780	Lifting Lever for 42133 and 42144.....
42131	20780	“ “ Bracket for 42133 and 42144.....
42132	20780	Lifting Lever Spring for 42133 and 42144.....
42133	---	Foot Lifter complete, Nos. 1301b, 4885, 6439, 42130 to 42132 and two each 1148E, 1229c and 1517J.....
42142	20779	Lifting Lever Connecting Rod for 42144
42143	20779	Rock Shaft complete for 42144, Nos. 2763, 2768, 6337, 7125 and two each 2770 and 12242.....
42144	---	Knee Lifter complete, Nos. 1301b, 42130 to 42132, 42142, 42143 and two each 1148E, 1229c and 1517J.....
42192	20786	Frame Side Cover (right) Lock Spring..
42195	20786	Needle Guard Holder.....
42205	20780	Feed Bar with 1253c.....

NO.	PLATE	NAME
42242	20786	Thread (looper, left hand) Eyelet.....
42244	7417	“ (looper, right hand) Pull-off Eyelet.....
42253	7412	Needle Bar Bushing (lower) for 132522.
42267	20782	Feed Dog, 24 teeth (16 teeth to the inch) for 42272.....
42268	20782	Presser Foot Chaining-off Finger for 132637.....
42270	---	Presser Foot Plate for 132637.....
42272	20782	Throat Plate for 42267.....
42376	---	Presser Lever 42069 with 42045.....
42418	---	Tension (looper, right hand) Screw Stud 828c with 1560c.....
42483	7413	Needle Bar Thread Retainer Disc.....
44209	---	Tension (needle thread) Screw Stud 916c with 1560c.....
46548	7418	Bench Stand Cover Rest (felt) for 79768.....
50117c	20785	Looper (left hand) Set Screw for 132566
50148c	7414	Tension (looper, left hand) Screw Stud for 124687.....
50150c	7416	Cloth Plate Hinge Stud Set Screw....
50200c	7413	Looper (right hand) and Spreader Lever Ball Stud Set Screw for 132698.....
50200c	7413	Needle Bar Crank (front) Set Screw for 132597.....
50253J	20781	Feed Eccentric Cover Screw for 132634.
51145c	20781	“ Regulating Screw for 132644.....
51292c	20781	“ Connecting Rod Hinge Screw. ...
51332c	---	Frame Rotary Shaft Bushing (front) Set Screw.....
51332c	---	Frame Rotary Shaft Flanged Bushing (back) Set Screw.....
51576E	7419	Machine Base Screw Stud Nut for 132592.....
54477	7419	Machine Base Screw Stud for 132592...
54883	7414	Tension (looper, left hand) Spring.....
56864	5566	Chain Hook (large) for 6439.....
56865	7418	“ “ (small) for 6439.....
57076	7414	Tension (looper, right hand) Thread Guide.....
62527	20782	Presser Foot Hinge Pin for 132637.....
68350	7416	Arm Oil Cup.....
68497	---	Looper (left hand) Lever Connecting Stud Oil Pad for 132567.....
68547	7418	Wrench for 1324 and 1728 (Accessories).

NO.	PLATE	NAME
79768	-----	Bench Stand with 27998 two each 28291, 46548, wood screws 1½ in. No. 12 and eight wood screws 5⁄8 in. No. 5.....
120341	5566	Tweezers (curved) Accessories.....
120344	5566	Oiler (copper plated) with 120345 (Accessories).....
120345	5566	Oiler Spout, 5 in. long, for 120344.....
120440	5566	Screw Driver (Accessories).....
124687	-----	Tension (looper, left hand) Screw Stud 50148c with 1560c.....
131019	20784	Machine Base Oil Pipe for 132592.....
131020	20784	“ “ “ “ Valve for 132592
*132522	---	Arm with 42253, 132580 and two each 462c, 624c and 132589.....
132524	20779	Cloth Plate with 132525, for 132527 ...
*132525	-----	“ “ Hinge Bracket for 132524..
132526	7416	“ “ “ Stud.....
132527	---	Cloth Plate complete, Nos. 42005, 42108, 132524, 132601, two 236c and five 233e.....
132528	20786	Feed Bar Hinge Pin.....
132529	20781	“ Connecting Rod with 171c, 1695j, 132530 and two 1057e, for 132643....
*132530	---	Feed Connecting Rod Cap for 132529..
*132531	-----	“ Eccentric for 132644.....
*132532	-----	“ “ Body for 132644.....
132533	20781	“ “ Oil Tube for 132644....
132536	20783	“ “ Lubricator with 132537
132537	20783	“ “ “ Oil Wick (braided cotton) for 132536.....
132539	20783	Feed Lifting Eccentric Connection....
132542	20783	“ Rock Shaft Hinge Pin with 132544.....
132543	20783	Feed Rock Shaft Hinge Pin Bushing...
132543	20783	Looper (right hand) and Spreader Lever Hinge Pin Bushing.....
132544	20783	Feed Rock Shaft Hinge Pin Bushing Oil Wick (braided cotton).....
132544	20783	Feed Rock Shaft Hinge Pin Oil Wick (braided cotton) for 132542.....
*132545	---	Frame.....
132546	20779	“ Bottom Cover with 132594.....
132547	20779	“ “ “ Gasket.....
132548	7416	“ Oil Cup.....
132549	20784	“ Rotary Shaft with 132558 and 132559, for 132616.....

NO.	PLATE	NAME
132550	7416	Frame Rotary Shaft Bushing (front) with 132552.....
132551	7416	Frame Rotary Shaft Bushing (front) Oil Wick (braided cotton).....
132551	7416	Frame Rotary Shaft Flanged Bushing (back) Oil Wick (braided cotton)....
132552	20785	Frame Rotary Shaft Bushing (front) Oil Pad (braided cotton) for 132550
132552	20785	Looper (left hand) Lever Hinge Stud Oil Pad (braided cotton) for 132569
132553	20783	Frame Rotary Shaft Crank with 1036c and 1375c.....
132554	20784	Frame Rotary Shaft Flanged Bushing (back) for 132694.....
132555	20780	Frame Rotary Shaft Flanged Bushing (back) Oil Pad, large (braided cotton) for 132694.....
132556	7416	Frame Rotary Shaft Flanged Bushing (back) Oil Pad, small (braided cotton) for 132694.....
132558	20780	Frame Rotary Shaft Oil Pad (braided cotton) for 132549.....
132559	20780	Frame Rotary Shaft Oil Pad Retainer for 132549.....
132566	20785	Looper (left hand) Lever with 50117c and two 1253c.....
132567	20785	Looper (left hand) Lever Connecting Stud with 68497.....
132569	20785	Looper (left hand) Lever Hinge Stud with 132552.....
132571	20785	Looper (left hand) Lever Hinge Stud Oil Wick (braided cotton).....
132573	7412	Looper (right hand) and Spreader Lever Ball Stud for 132695.....
132573	7412	Needle Bar Crank (back) Ball Stud for 132695.....
132574	7412	Looper (right hand) and Spreader Lever Connection with 132575, 132576 and four 1057e, for 132617.....
*132575	---	Looper (right hand) and Spreader Lever Connection Cap (lower) for 132574..
*132576	---	Looper (right hand) and Spreader Lever Connection Cap (upper) for 132574..
132577	7412	Looper (right hand) and Spreader Lever Connection Guide.....
132577	7412	Needle Bar Connecting Rod Guide....

NO.	PLATE	NAME
132580	7412	Needle Bar Bushing (upper) for 132522
132581	7412	" " " " Oil Pad (braided cotton).....
132582	7412	Needle Bar Connecting Link for 132615
132583	7412	" " " " Hinge Pin with 132584, for 132615.....
132584	7412	Needle Bar Connecting Link Hinge Pin Oil Pad (wick) for 132583.....
132585	7413	Needle Bar Connecting Rod with 132586, 132587 and four 1057e, for 132616.....
*132586	-----	Needle Bar Connecting Rod Cap (lower) for 132585.....
*132587	-----	Needle Bar Connecting Rod Cap (upper) for 132585.....
132588	7413	Needle Bar Crank (back) with 132590 and two 1259c.....
132589	7413	Needle Bar Crank (back) Bushing for 132522.....
132590	7413	Needle Bar Crank (back) Oil Pad (wick) for 132588.....
132591	7417	Thread (looper, right hand) Pull-off....
132592	-----	Machine Base complete, Nos. 131019, 131020, 132593, 132596, 132618, 132647, three each 9842, 51576e, 54477 and four each 935e, 42088 and 132595.....
132593	7419	Machine Base Oil Drain Strainer for 132592.....
132594	7419	Machine Base Thumb Screw Bushing for 132546.....
132595	7419	Machine Base Cushion (large) felt, for 132592.....
132596	7419	Machine Base Cushion (leather) for 132592.....
132597	7413	Needle Bar Crank (front) with 620c, 1259c and 50200c, for 132615.....
132598	7412	Needle Bar Connecting Bracket with 187e and 223e, for 132615.....
132599	7414	Tension (looper, left hand) Thread Guide.....
132601	20779	Cloth Plate Extension (lower) for 132527.....
132602	7418	Machine Base Thumb Screw Washer (Accessories).....
132603	20780	Frame Rotary Shaft Flanged Bushing (back) Oil Pad Retainer for 132694..

NO.	PLATE	NAME
132609	-----	Presser Foot Chaining-off Plate for 132637.....
132610	20782	Presser Foot Chaining-off Plate Collar with 240c, for 132637.....
132611	20782	Presser Foot Chaining-off Plate Collar Guide Pin for 132637.....
132612	-----	Presser Foot Shank with 735c, for 132637
132615	-----	Needle Bar Crank (front) 132597 with 132582, 132598 and two 132583.....
132616	-----	Frame Rotary Shaft 132549 with 132585 and 132695.....
132617	-----	Looper (right hand) and Spreader Lever Connection 132574 with 132553 and 132695.....
132618	7419	Machine Base Cushion (small) felt, for 1407 or 1408, for 132592.....
132621	7412	Needle Bar Bushing (upper) Oil Pad Cover.....
132622	7417	Thread (needle) Eyelet.....
132623	7417	" " " " Take-up.....
132625	20780	Feed Rock Shaft for 132626.....
132626	-----	Feed Rock Shaft complete, Nos. 42021 and 132625.....
132629	7417	Thread (looper, left hand) Eyelet.....
132630	20785	Looper (right hand).....
132631	20785	Spreader.....
132632	20784	Balance Wheel, 1 $\frac{7}{8}$ in. pulley, with 446c and 1285c.....
132634	-----	Feed Eccentric Cover Holder 42102 with 132651 and two 50253a.....
132635	20783	Feed Lifting Eccentric with two 462c..
132636	20779	Frame Top Cover.....
132637	20782	Presser Foot (spring hinged) complete, Nos. 233j, 14058, 42268, 42270, 62527 and 132609 to 132612.....
132638	20784	Frame Side Cover (left) with 19045....
132643	-----	Feed Connecting Rod 132529 with 132644.....
132644	20781	Feed Eccentric complete for 132643, Nos. 201j, 19047, 51145c, 132531 to 132533 and two 1036c.....
132645	20785	Looper (left hand) Lever Connecting Stud Hinge Pin.....
132647	20779	Machine Base for 132592.....
132651	20781	Feed Eccentric Cover for 132634.....

NO.	PLATE	NAME
*132692	-----	Frame Rotary Shaft Oil Sling Cover for 132694.....
132694	-----	Frame Rotary Shaft Flanged Bushing (back) 132554 with 132555, 132556, 132603 and 132692.....
132695	-----	Looper (right hand) and Spreader Lever Ball Stud 132573 with 132696, for 132617.....
132695	-----	Needle Bar Crank (back) Ball Stud 132573 with 132696, for 132616.....
132696	-----	Looper (right hand) and Spreader Lever Ball Stud Oil Pad (felt) for 132695....
132696	-----	Needle Bar Crank (back) Ball Stud Oil Pad (felt) for 132695.....
132698	-----	Looper (right hand) and Spreader Lever with 233E, 241E and 50200c, for 132703.....
132699	-----	Looper (right hand) and Spreader Lever Hinge Pin with 132700, for 132703....
132700	-----	Looper (right hand) and Spreader Lever Hinge Pin Bushing Oil Pad (braided cotton).....
132700	-----	Looper (right hand) and Spreader Lever Hinge Pin Oil Pad (braided cotton) for 132699.....
132703	-----	Looper (right hand) and Spreader Lever 132698 with 132699.....
*150059	-----	Thread Unwinder Thread Separator Bracket for 150086.....
150060	20787	Thread Unwinder Thread Separator Bracket Arm with 164J and 9525, for 150087.....
*150085	-----	Thread Unwinder Thread Separator for 150086.....
150086	20787	Thread Unwinder Thread Separator 150085 with 150059, for 150087.....
150087	-----	Thread Unwinder Thread Separator complete for 150088, Nos 164J, 9525, 150060 and 150086.....
150088	20787	Thread Unwinder complete, for two spools, Nos. 150087, 201696J, 202490, 225257, 225324, 225326, 225388, two each 150203, 225391 and three wood screws $\frac{7}{8}$ in. No. 12.....
150203	-----	Thread Unwinder Spool Rest Cushion (felt) for 150088.....

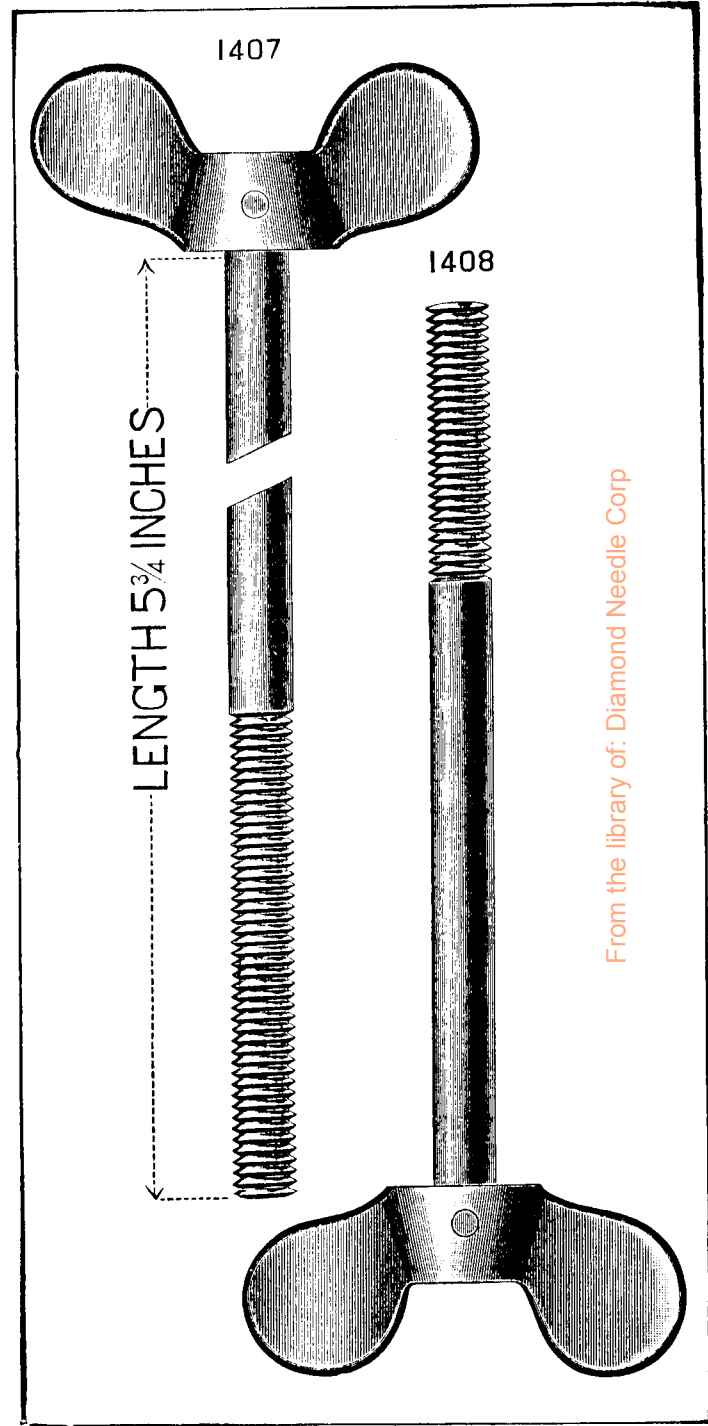
NO.	PLATE	NAME
200383c	7418	Thread Unwinder Spool Rest Rod Set Screw for 202490.....
201018c	7418	Thread Unwinder Spool Rest Set Screw for 225395.....
201696J	7418	Thread Unwinder Thread Guide Lock Nut for 150088.....
202490	20787	Thread Unwinder Spool Stand with 200383c, for 150088.....
225257	20787	Thread Unwinder Spool Rest (for two spools) with 201018c, for 150088.....
225322	7418	Thread Unwinder Thread Guide Rod Washer for 225324.....
225324	20787	Thread Unwinder Thread Guide Rod with 208E and 225322, for 150088....
225326	7418	Thread Unwinder Thread Guide Position Cup for 150088.....
225388	20787	Thread Unwinder Spool Rest Rod for 150088.....
225390	7234	Thread Unwinder Thread Cone Holder, for inverted cones, for 150088.....
225391	20787	Thread Unwinder Thread Guide for 150088.....

Genuine Singer Needles should be used
in Singer Machines.
These Needles and their Containers
are marked with the
Company's Trade Mark "SIMANCO." 1

Needles in Containers marked
"For Singer Machines"
are not Singer made needles. 2

From the library of: Diamond State College

ILLUSTRATIONS OF PARTS
FOR
MACHINE No. 81-63



From the library of: Diamond Needle Corp

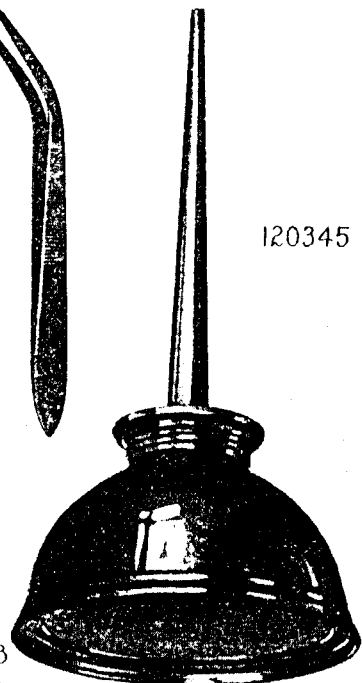
ILLUSTRATIONS OF PARTS
FOR
MACHINE No. 81-63

PLATE 5566—ONE-HALF SIZE

120341



120344



120345

120440 42090



8908



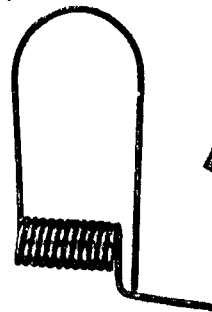
42089



4822



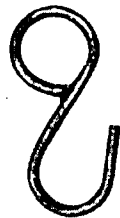
4883



4882



4879



56864

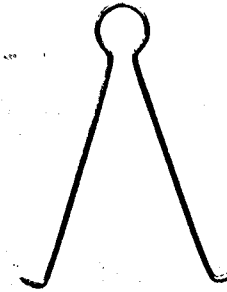


PLATE 7234—ONE-HALF SIZE

27739



225390



From the library of: Diamond Needle Corp

PLATE 7412—FULL SIZE

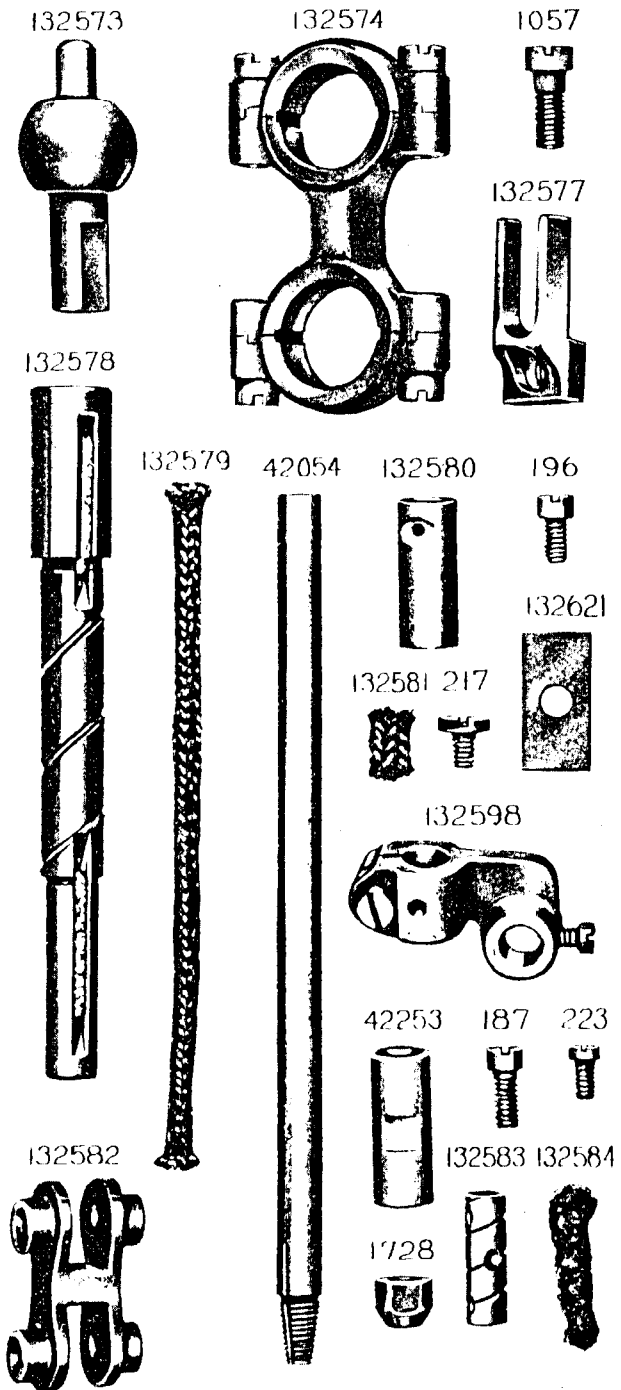
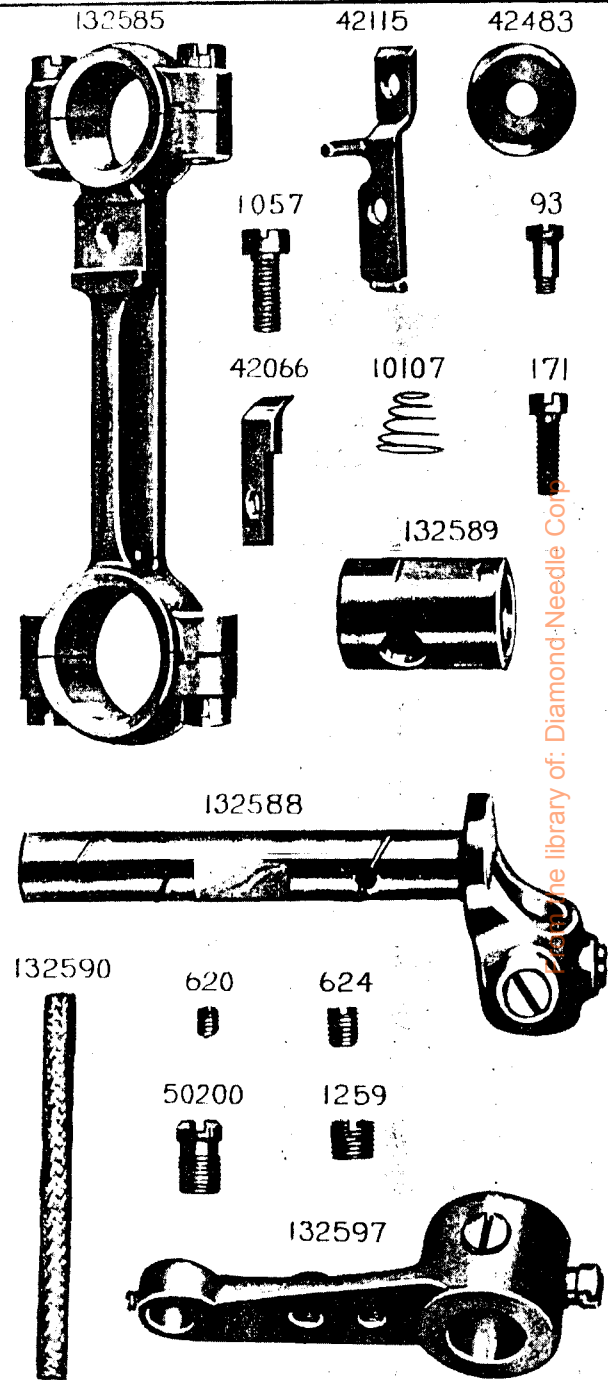


PLATE 7413—FULL SIZE



The library of: Diamond-Needle Corp.

PLATE 7414—FULL SIZE

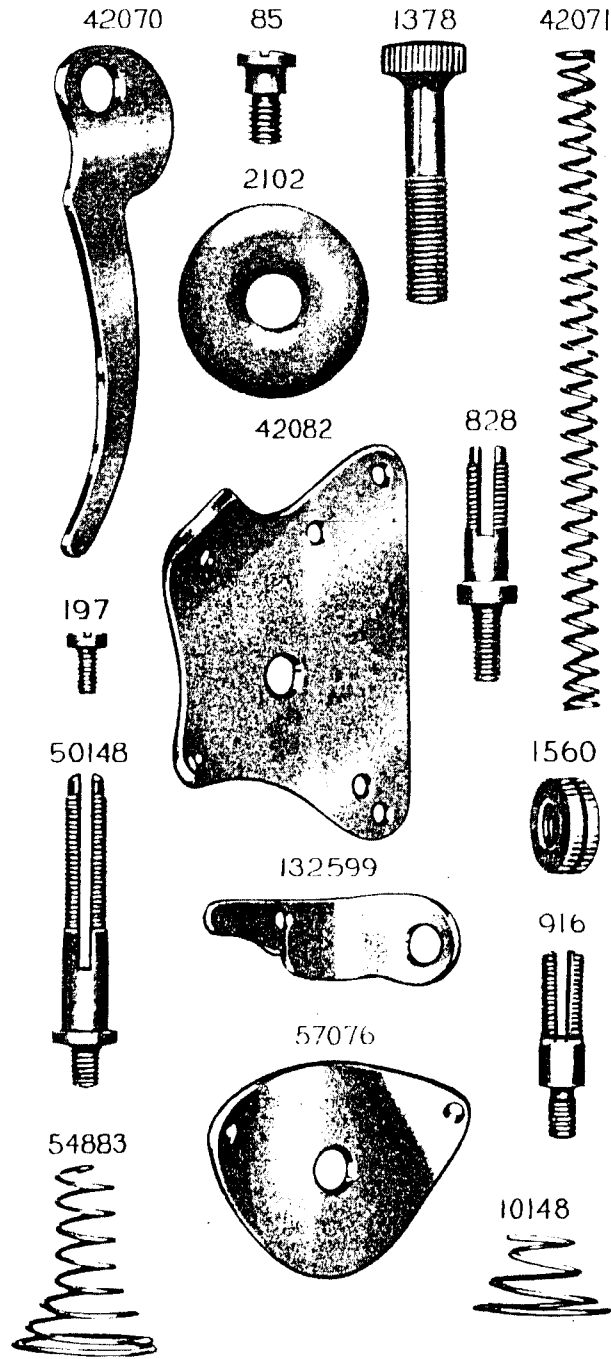


PLATE 7416—FULL SIZE

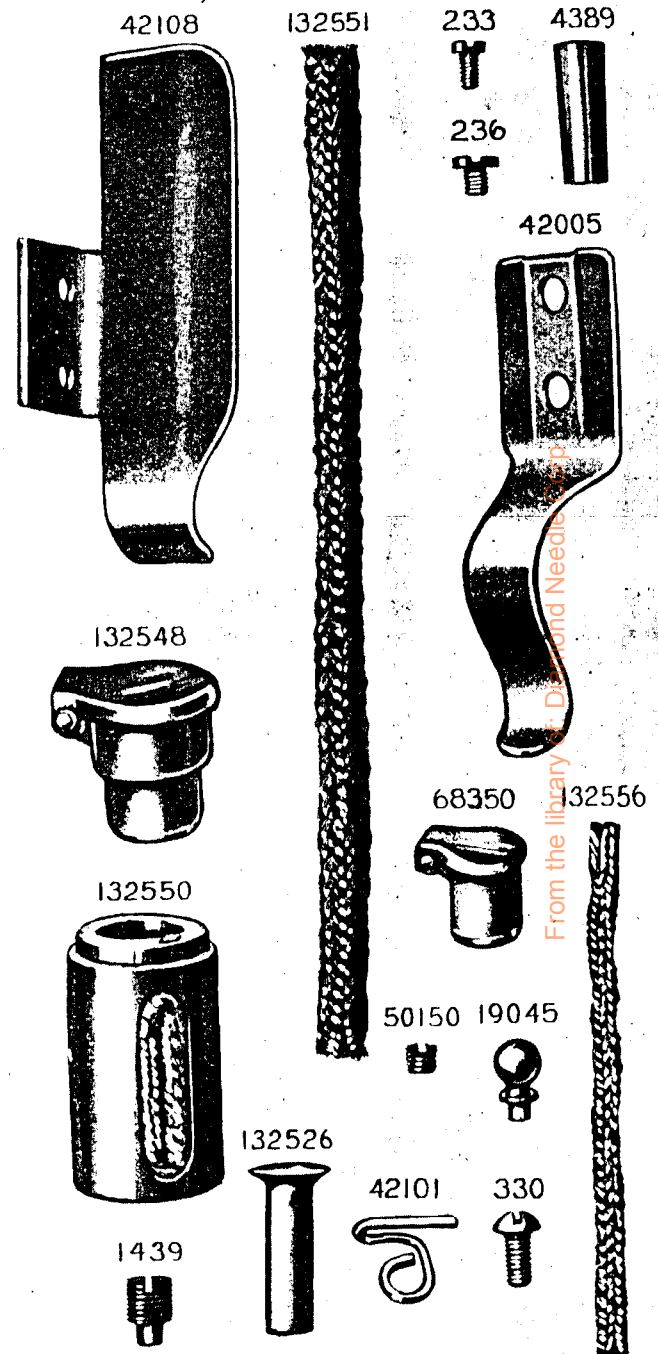


PLATE 7417—FULL SIZE

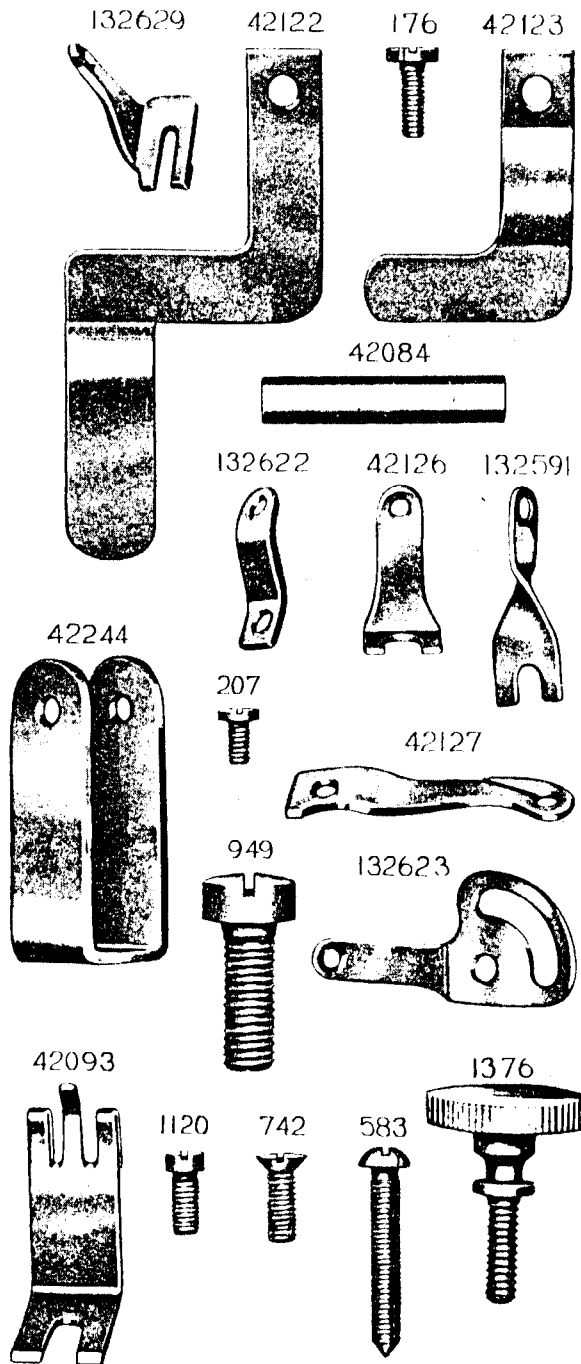


PLATE 7418—FULL SIZE

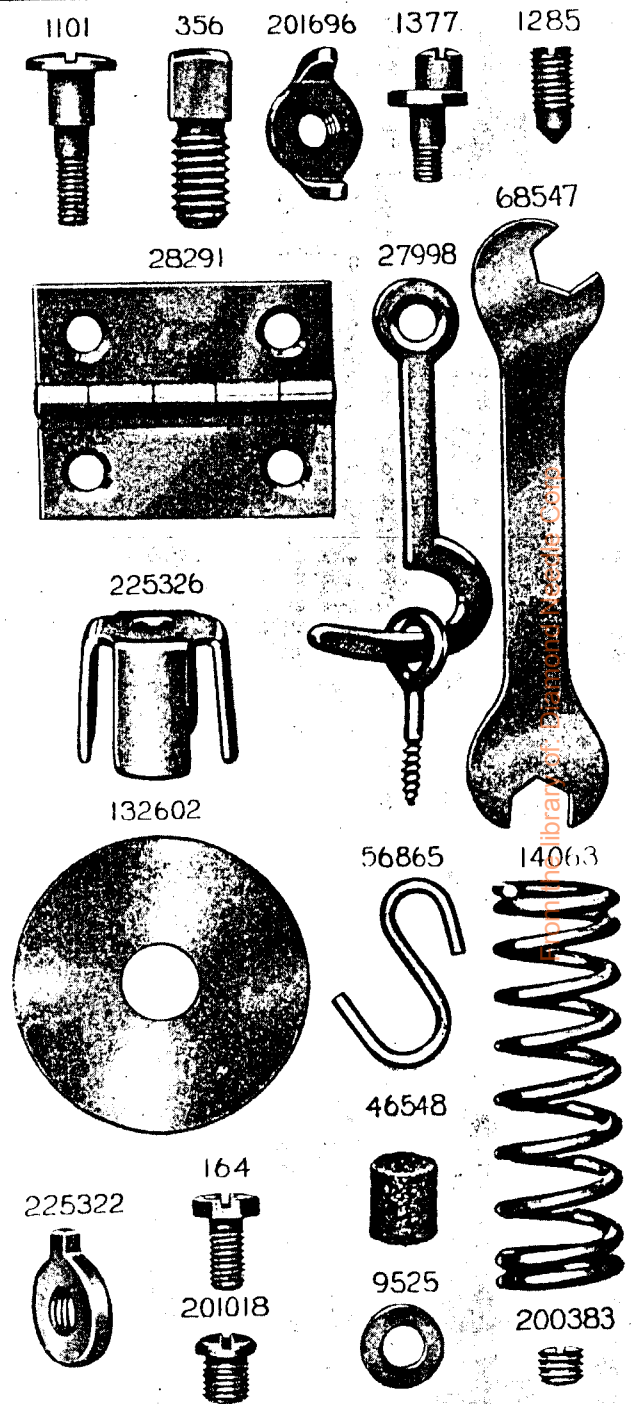
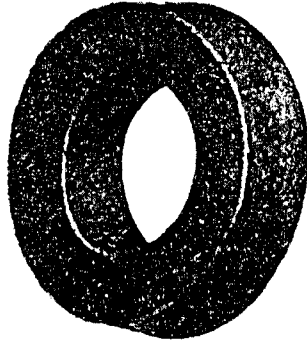


PLATE 7419—FULL SIZE

132596



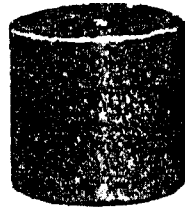
132595



132618



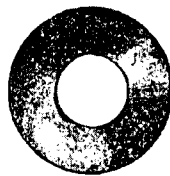
42088



51576



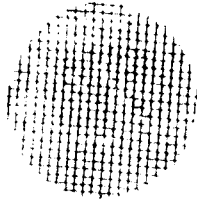
9842



54477



132593



935

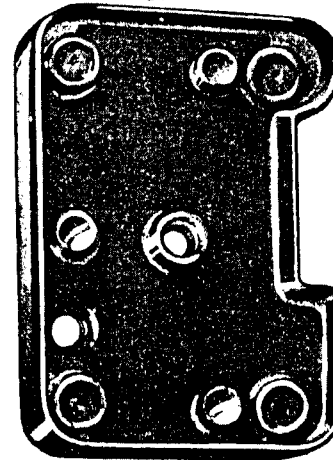


132594

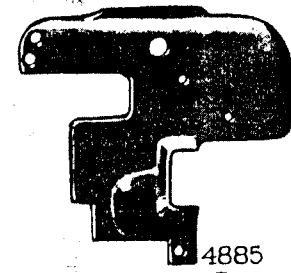


PLATE 20779—ONE-FOURTH SIZE

132647



132636



4885

42142



4881



4884

132546



132547



7125



42143



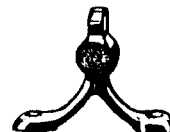
2770

12242

6337

2763

2770



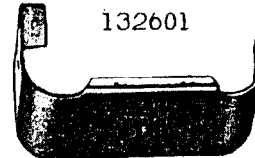
2765

2766

132524



132601



2767

From the Army of Dairies and Milk Co.

PLATE 20780—FULL SIZE

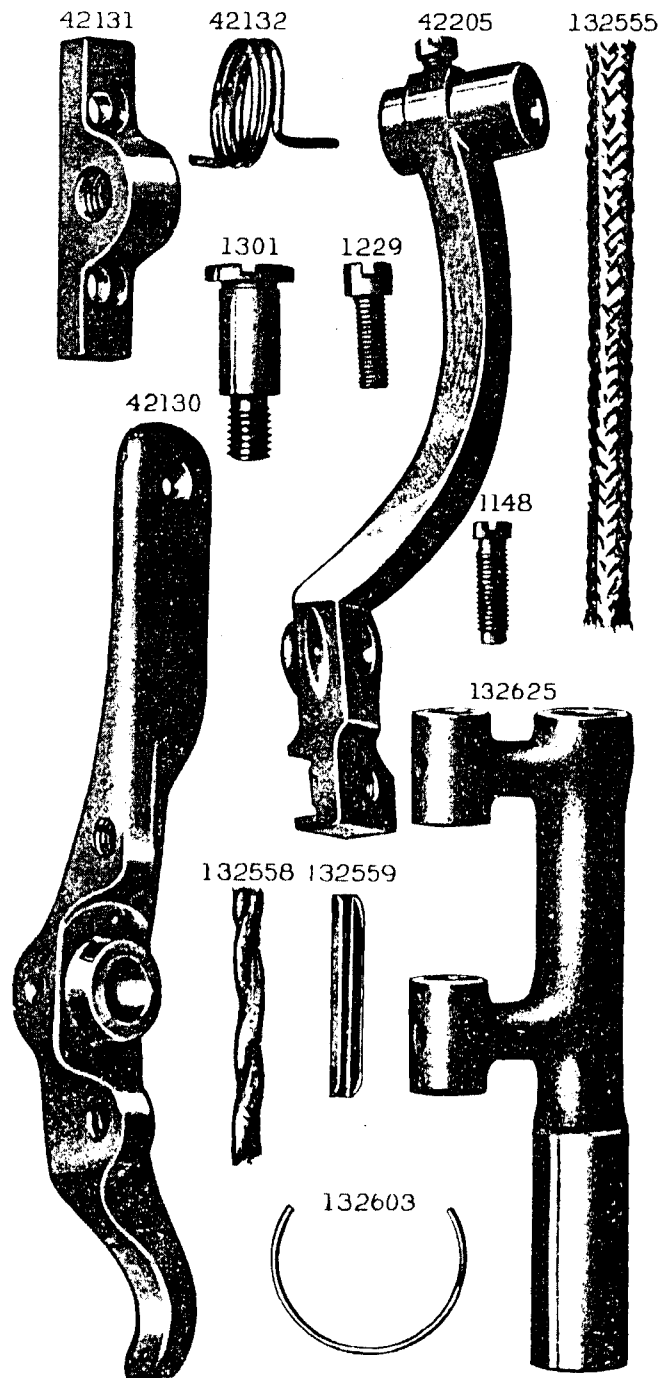


PLATE 20781—FULL SIZE

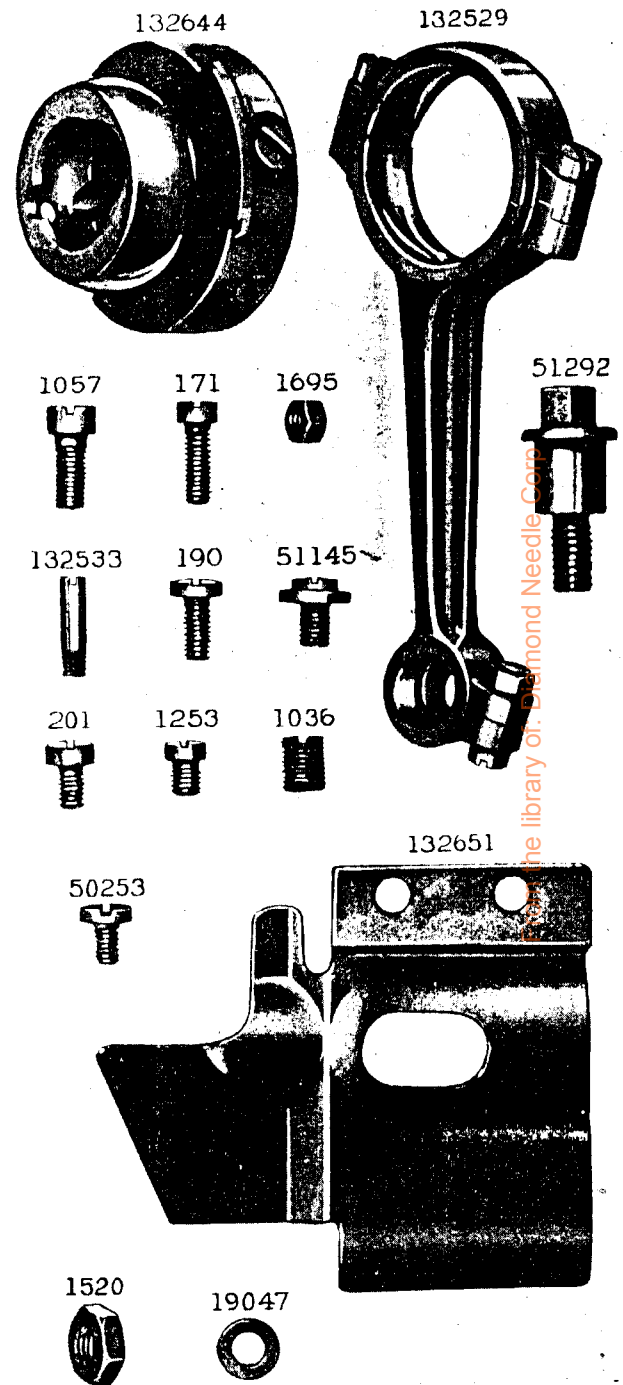


PLATE 20782—FULL SIZE

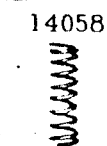
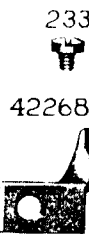
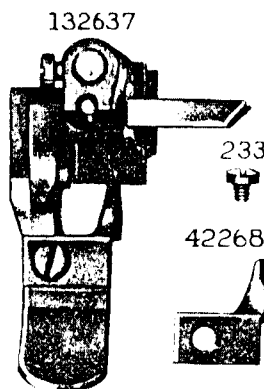
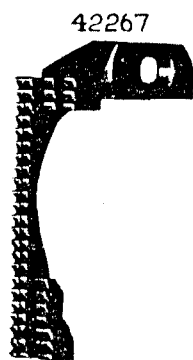
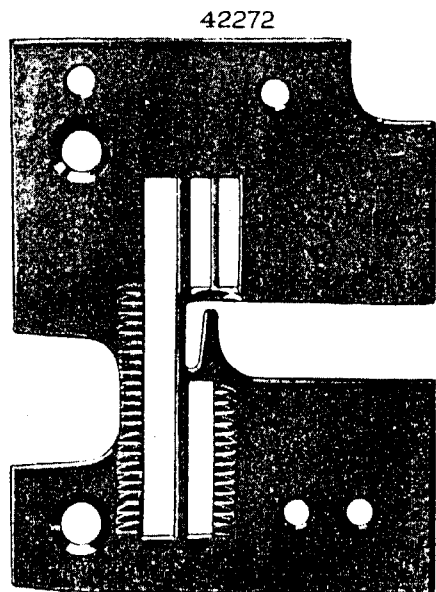


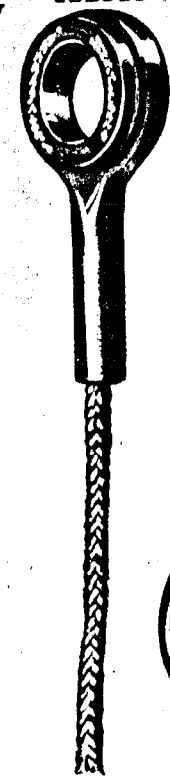
PLATE 20783—FULL SIZE

132542 132544

132537

132536

132635



462



42021

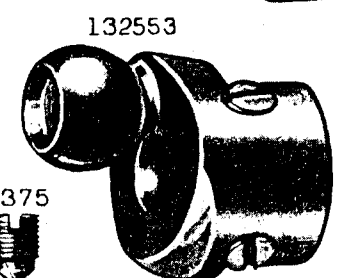
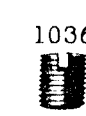
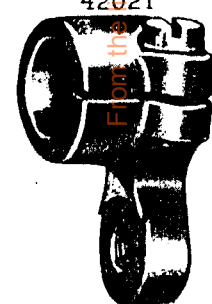


PLATE 20784—ONE-HALF SIZE

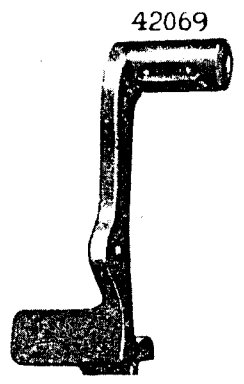
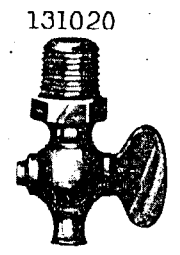
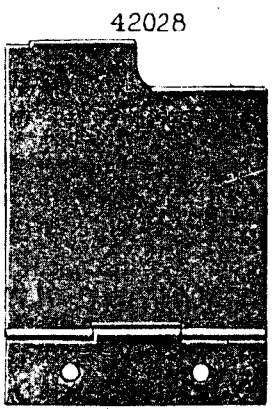
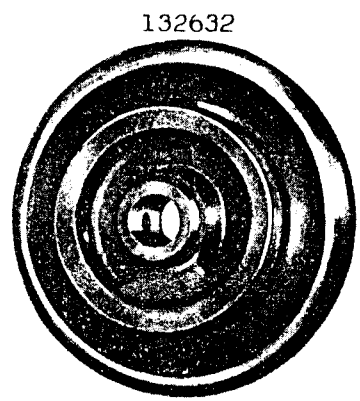
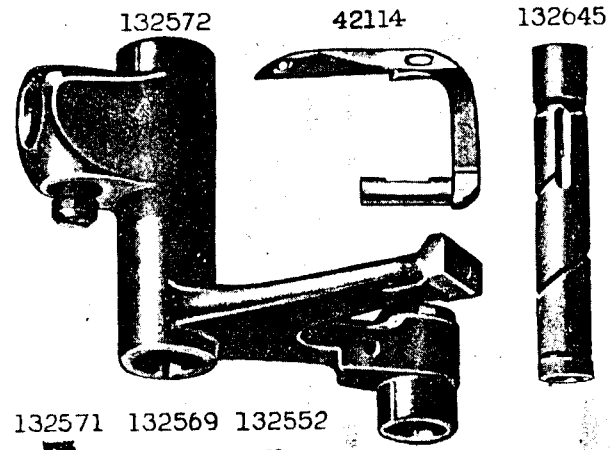
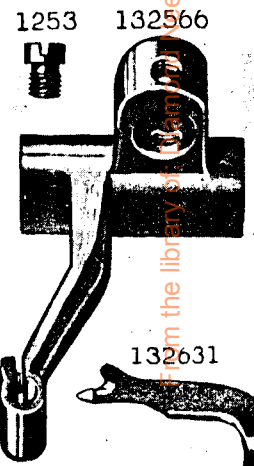
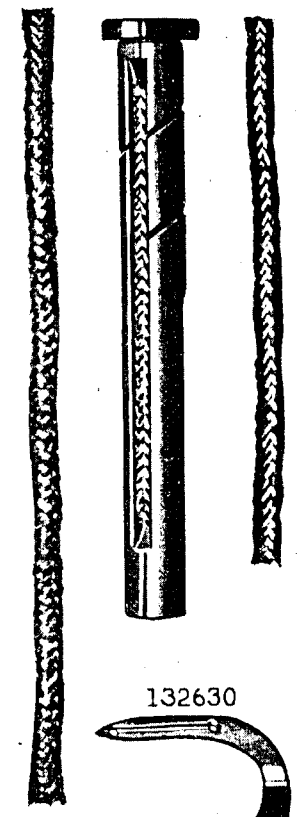


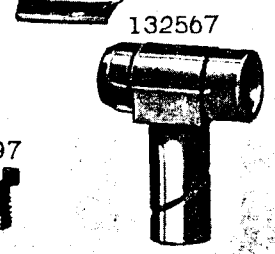
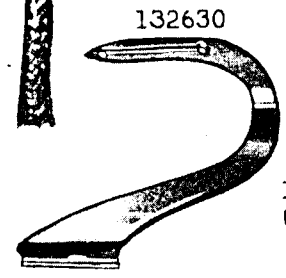
PLATE 20785—FULL SIZE



132571 132569 132552



132631



From the library of  Wampole Needle Corp

PLATE 20786—FULL SIZE

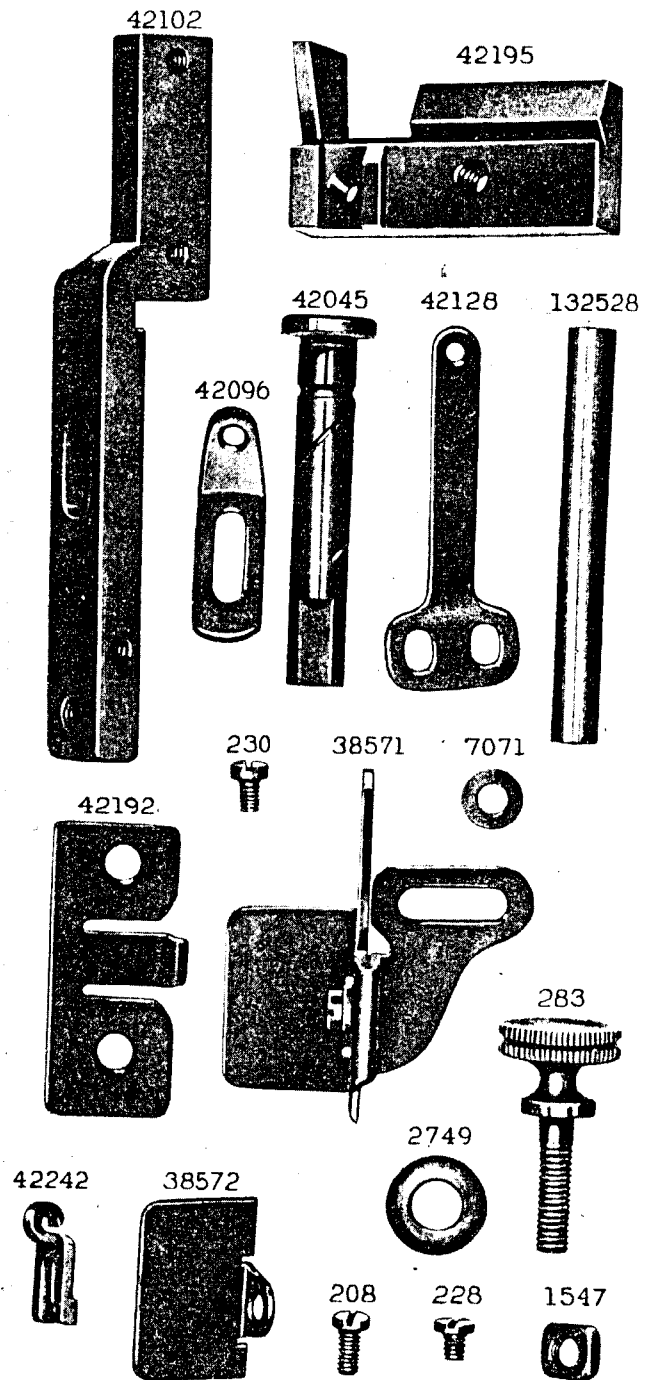
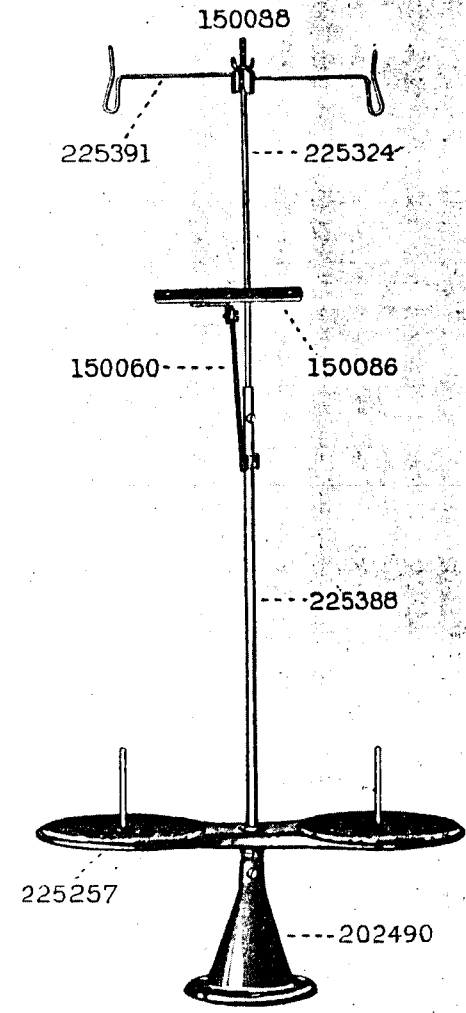


PLATE 20787—ONE-SIXTH SIZE



From the library of: Diamond Needle Corp